









Klinkenzüge		Latch locks		Ouvres-moules	
Z4-12-	 deutsch 6.84-94 english 6.95-105 français 6.106-116	 Z4-12-Type			
Z4-17-	 deutsch 6.84-94 english 6.95-105 français 6.106-116	 Z4-17-Type			
Z4-22-	 deutsch 6.84-94 english 6.95-105 français 6.106-116	 Z4-22-Type			

*  deutsch 6.80
english 6.91
français 6.102

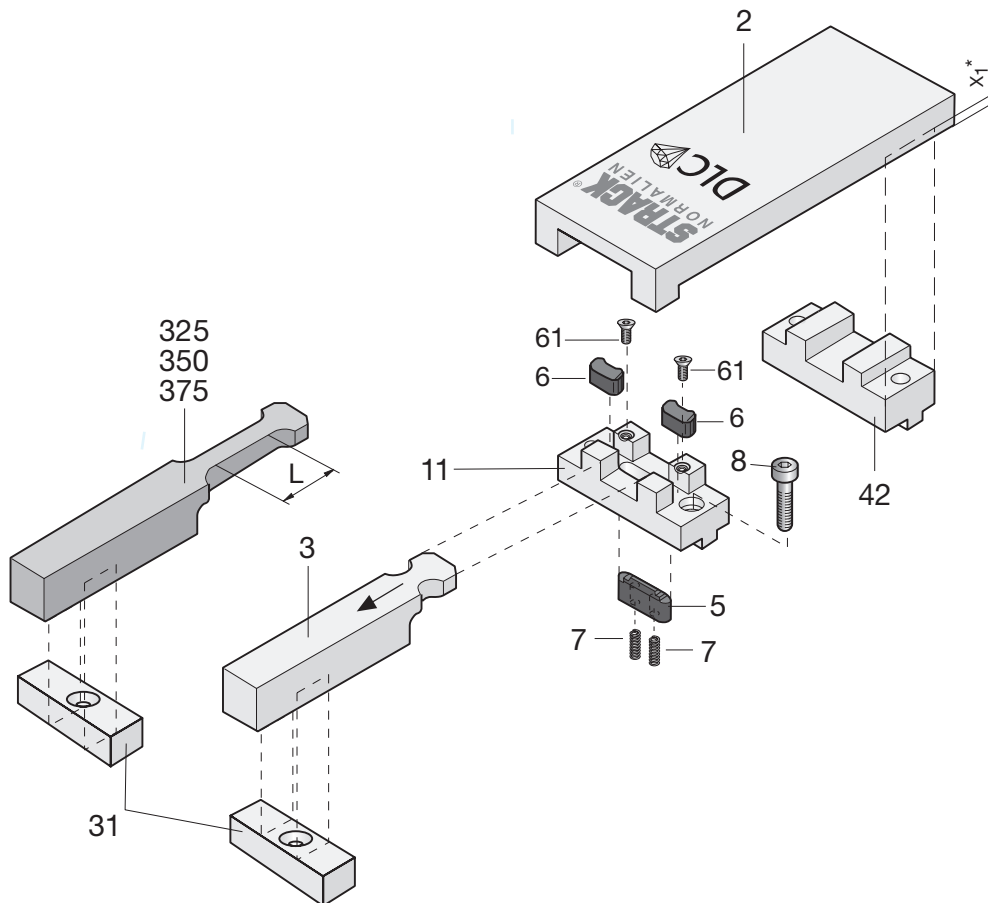

Stückliste
Parts list
Liste des pièces

 Z4-12-Type / Z4-17-Type / Z4-22-Type

Type	Pos. Item Pos.	Stück Quant. Nbr.	Bezeichnung	Description	Désignation	Mat.-Nr. Mat.-No Mat.Nr.
011	11	1	Klinkengehäuse	Latch housing	Support mobile	
02	2	1	Steuerplatte	Control plate	Plaque support	1.2162 ¹⁾
03	3	1	Zugleiste	Latch bar	Crochet	1.2162 ¹⁾
031	31	1	Passfeder	Parallel key	Clavette	1.2162 ¹⁾
0325	325	1	Zugleiste m. Verzögerung, L = 25 mm	Latch bar with delay, L = 25 mm	Crochet de traction à retardement, L = 25 mm	1.2162 ¹⁾
0350	350	1	Zugleiste m. Verzögerung, L = 50 mm	Latch bar with delay, L = 50 mm	Crochet de traction à retardement, L = 50 mm	1.2162 ¹⁾
0375	375	1	Zugleiste m. Verzögerung, L = 75 mm	Latch bar with delay, L = 75 mm	Crochet de traction à retardement, L = 75 mm	1.2162 ¹⁾
042	42	1	Traverse	Steady	Tasseau	1.1730
05	5	1	Sperre	Catch stop	Verrou	DLC
06	6	2	Raste	Catch	Clavette	DLC

¹⁾ ~ 630 HV10
Einatzhärtetiefe (Eht)
Thickness of hardened layer = 0,4 - 0,6 mm
Épaisseur de la couche durcie

Normalien
Standard parts
Elements standard

Z4-12

 Strack Norm

Strack Norm	Pos. Item Pos.	Stück Quant. Nbr.	Bezeichnung	Description	Désignation	Mat.-Nr. Mat.-No Mat.Nr.
SN3550-M3-6	61	2	Senkschraube	Countersunk screw	Vis à tête fraisée	SN
SN2500-3-12	7	2	Druckfeder	Spring	Ressort de pression du verrou	SN
SN3540-M6-20	8	2	Zylinderschraube	Cap screw	Vis 6 pans creux	SN

6

Normalien
Standard parts
Elements standard

Z4-17

 Strack Norm

Strack Norm	Pos. Item Pos.	Stück Quant. Nbr.	Bezeichnung	Description	Désignation	Mat.-Nr. Mat.-No Mat.Nr.
SN3550-M5-10	61	2	Senkschraube	Countersunk screw	Vis à tête fraisée	SN
SN2500-3-12	7	2	Druckfeder	Spring	Ressort de pression du verrou	SN
SN3540-M8-25	8	2	Zylinderschraube	Cap screw	Vis 6 pans creux	SN

Normalien
Standard parts
Elements standard

Z4-22

 Strack Norm

Strack Norm	Pos. Item Pos.	Stück Quant. Nbr.	Bezeichnung	Description	Désignation	Mat.-Nr. Mat.-No Mat.Nr.
SN3550-M5-10	61	2	Senkschraube	Countersunk screw	Vis à tête fraisée	SN
SN2500-5-15	7	2	Druckfeder	Spring	Ressort de pression du verrou	SN
SN3540-M10-30	8	2	Zylinderschraube	Cap screw	Vis 6 pans creux	SN

D 3002A 07.2018

Klinkenzüge

Latch locks

Ouvres-moules

CAD-INFO

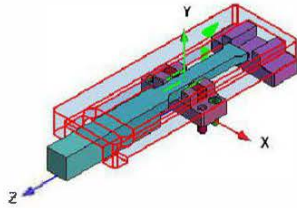

Z4-x- 0-0
-25-
-50-
-75-

